



Juncos

Juncos 1L



Juncos 3L



Juncos 6L



Juncos 9L



Wall Piercing

Wall Piercing 1X



Wall Piercing 2X



Wall Piercing 4X



Wall Piercing 2X Line



Soft Spun

Soft Spun Small
Halogen/ Fluorescent/
LED



Soft Spun Large
Halogen/ Fluorescent/
LED



Abajourd'hui

Abajourd'hui Small



Abajourd'hui Large



Juncos Designed By Flos Soft Architecture

Juncos 1L

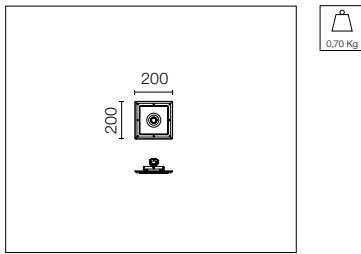

Semi-recessed LED luminaire for indoor applications. Seamless integration in the architectural environment by Soft Architecture technology. Power supply not included. See drivers in next page.

Luminaria LED de interiores semiempotrada que combinada con la tecnología Soft Architecture se integra perfectamente en el espacio arquitectural. Fuente de alimentación no incluida. Ver drivers en la siguiente página.

Pre-wired product to be connected to constant current.

Producto precableado para su conexión a corriente constante.

Juncos 3L

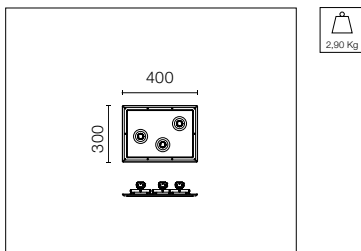
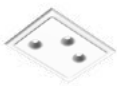

Pre-wired product for serial connection to constant current.

Producto precableado en serie para su conexión a corriente constante.

Juncos 6L

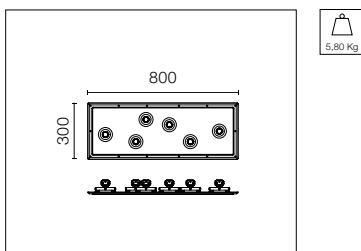
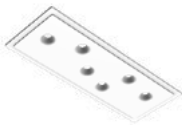

Pre-wired product for serial connection to constant current.

Producto precableado en serie para su conexión a corriente constante.

Juncos 9L

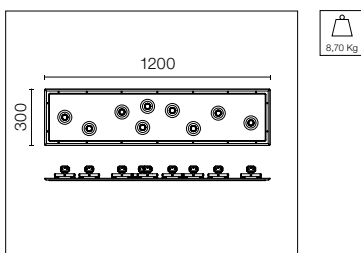
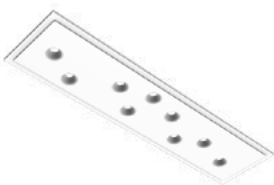

Pre-wired product for serial connection to constant current.

Producto precableado en serie para su conexión a corriente constante.

Soft Plate / Placa Soft

Juncos 1L

SA.5200.5.120

Juncos 3L

SA.5201.5.120

Juncos 6L

SA.5202.5.120

Juncos 9L

SA.5203.5.120

Junco 250 mm

Light Source: Power LED DC 700 mA - 2,1W - 216 lm - 3000K/CRI 80 / 2,1W - 182 lm- 2700K/CRI 90

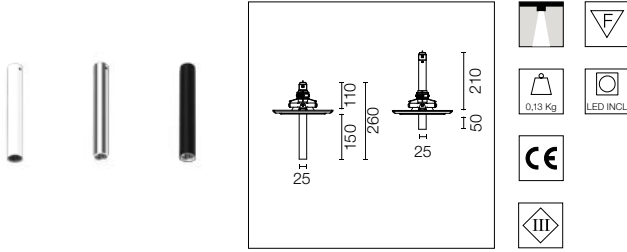

Luminaire that offers many possibilities. Can be individually focused and their recessed height is adjustable. Available in a black, white and chrome finish.

Luminaria que ofrece gran versatilidad. Individualmente orientable y nivel de empotramiento regulable. Disponible en acabado negro, blanco y cromo.

Junco 400 mm

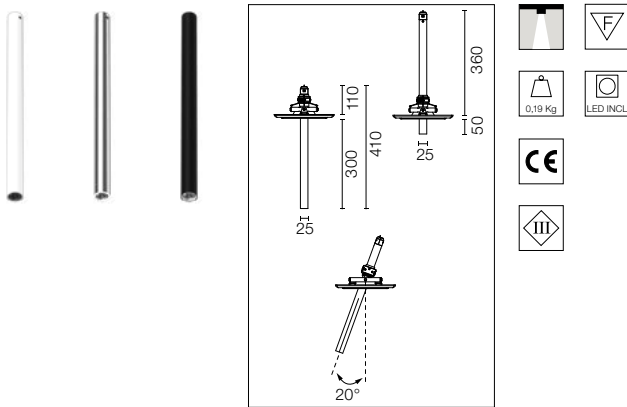

Junco 250 mm

2700K

- 08.8595.40A
- ◐ 08.8595.06A
- 08.8595.AAA

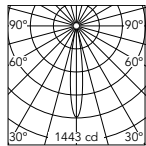

Beam Angle: 15°

h(m)	E(lx)	D(m)
1	1443	0.27
2	361	0.53
3	160	0.80
4	90	1.07
5	58	1.34

Luminous flux luminaire
130 lm

3000K

- 08.8590.40A
- ◐ 08.8590.06A
- 08.8590.AAA

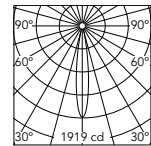

Beam Angle: 15°

h(m)	E(lx)	D(m)
1	1919	0.27
2	480	0.53
3	213	0.80
4	120	1.07
5	77	1.34

Luminous flux luminaire
173 lm

Junco 400 mm

2700K

- 08.8596.40A
- ◐ 08.8596.06A
- 08.8596.AAA

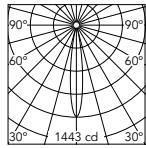

Beam Angle: 15°

h(m)	E(lx)	D(m)
1	1443	0.27
2	361	0.53
3	160	0.80
4	90	1.07
5	58	1.34

Luminous flux luminaire
130 lm

3000K

- 08.8591.40A
- ◐ 08.8591.06A
- 08.8591.AAA

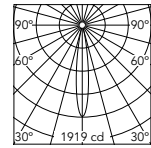

Beam Angle: 15°

h(m)	E(lx)	D(m)
1	1919	0.27
2	480	0.53
3	213	0.80
4	120	1.07
5	77	1.34

Luminous flux luminaire
173 lm

Drivers / Equipos

Non dimmable continuous current power supply of 17W, 700mA - 100/240V - 50/60Hz.

Fuente de alimentación de corriente constante 17W, 700mA - 100/240V - 50/60Hz.

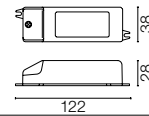

60.8655

Non dimmable continuous current power supply of 32W, 700mA - 220/240V - 50/60Hz.

Fuente de alimentación de corriente constante 32W, 700mA - 220/240V - 50/60Hz.

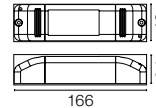

60.8656

Continuous current power supply of 25W, 120-240V - 50/60Hz with power current selected through adjustable 700mA 1-10V switch or push dimming.

Fuente de alimentación de corriente constante 25W, 120-240V / 50-60Hz con corriente de alimentación seleccionable mediante switch 700mA regulable 1-10V o push dimming.

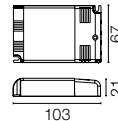

60.8533

Max. distance from LED driver / Distancia máxima del equipo de LED

Constant current driver (700mA) / Equipo de corriente constante

Distance / Distancia	10 m	20 m	50 m
Cable section / Sección de cable	0,5mm ²	1mm ²	2,5mm ²

Wall Piercing 1X Designed By Ron Gilad

Light Source: LED White 1x6,4W - 416 lm - 2700K/CRI>90 / LED RGB 1x7,4W

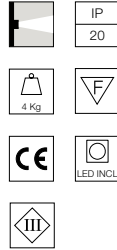
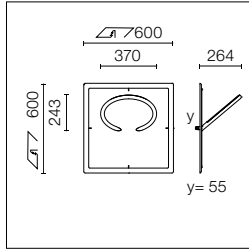

Soft technology semi-recessed luminaire for ceiling or wall mounting. Available in white LED or RGB versions. Control gear not included.

Luminaria semi-empotrada para ser instalada a techo o pared. Disponible en versiones de LED blanco o RGB. Equipo y controladores no incluidos.

LED modules included. For power supply and dimming interface see LED drivers.

Módulos LED incluidos. Para unidad de alimentación e interfaz regulable ver controladores LED.

- LED White
- SA.5020.5A120
- SA.5020.5A180

- LED RGB
- SA.5020.6A120
- SA.5020.6A180

Wall Piercing 2X Designed By Ron Gilad

Light Source: LED White 2x6,4W - 2x416 lm - 2700K/CRI>90 / LED RGB 2x7,4W

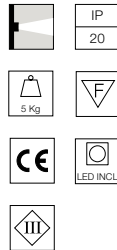
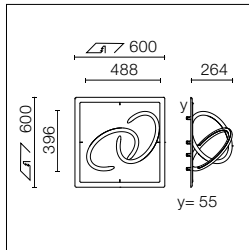

Soft technology semi-recessed luminaire for ceiling or wall mounting. Available in white LED or RGB versions. Control gear not included.

Luminaria semi-empotrada para ser instalada a techo o pared. Disponible en versiones de LED blanco o RGB. Equipo y controladores no incluidos.

LED modules included. For power supply and dimming interface see LED drivers.

Módulos LED incluidos. Para unidad de alimentación e interfaz regulable ver controladores LED.

- LED White
- SA.5021.5A120
- SA.5021.5A180

- LED RGB
- SA.5021.6A120
- SA.5021.6A180



Wall Piercing 4X Designed By Ron Gilad

Light Source: LED White 4x6,4W - 4x416 lm - 2700K/CRI>90 / LED RGB 4x7,4W

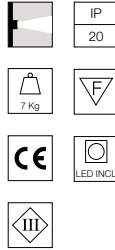
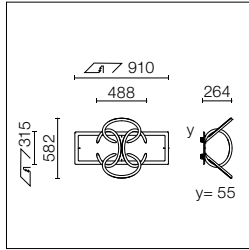
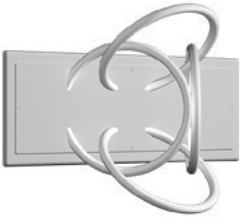

Soft technology semi-recessed luminaire for ceiling or wall mounting. Available in white LED or RGB versions. Control gear not included.

Luminaria semi-empotrada para ser instalada a techo o pared. Disponible en versiones de LED blanco o RGB. Equipo y controladores no incluidos.

LED modules included. For power supply and dimming interface see LED drivers.

Módulos LED incluidos. Para unidad de alimentación e interfaz regulable ver controladores LED.

LED White
 SA.5022.5A120
 SA.5022.5A180

LED RGB
 SA.5022.6A120
 SA.5022.6A180

Wall Piercing 2X Line Designed By Ron Gilad

Light Source: LED White 2x6,4W - 2x416 lm - 2700K/CRI>90 / LED RGB 2x7,4W

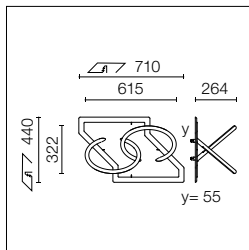

Soft technology semi-recessed luminaire for ceiling or wall mounting. Available in white LED or RGB versions. Control gear not included.

Luminaria semi-empotrada para ser instalada a techo o pared. Disponible en versiones de LED blanco o RGB. Equipo y controladores no incluidos.

LED modules included. For power supply and dimming interface see LED drivers.

Módulos LED incluidos. Para unidad de alimentación e interfaz regulable ver controladores LED.

LED White
 SA.5023.5A120
 SA.5023.5A180

LED RGB
 SA.5023.6A120
 SA.5023.6A180



SOFT ARCHITECTURE | 3D

LED DRIVERS

For Wall Piercing

Non Dimmable

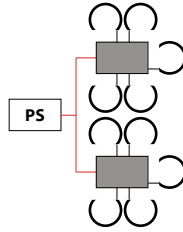

Wiring Cableado

5 male pole distributor for easy connection with feed cable. It's able to connect up to 5 Wall Piercings. Electronic power supply not included.

Distribuidor macho de 5 polos para una fácil conexión con cable de alimentación. Posibilidad de conectar hasta 5 Wall Piercings. Unidad de alimentación electrónica no incluida.

White

06.1003.00

Dimmable 1-10V

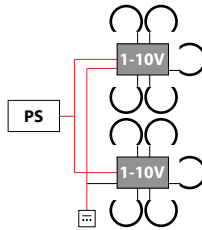

Dimmable Interface Interfaz Regulable

1-10V interface. 5 pole distributor for easy connection integrated. It's able to connect up to 5 Wall Piercings. Electronic power supply not included.

Interfaz de 1-10V. Distribuidor de 5 polos para una fácil conexión integrada. Posibilidad de conectar hasta 5 Wall Piercings. Unidad de alimentación electrónica no incluida.

White

06.1011.00

1-10V

Dimmable Interfaces Interfaces Regulables

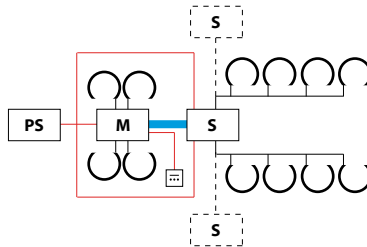

DALI Master interface with 5 pole distributor for easy connection integrated. It's able to control up to 5 Wall Piercing. If more Wall Piercings are in the same installation it's necessary to expand the signal with Slave interfaces. Electronic power supply not included.

Interfaz "Master" DALI con distribuidor de 5 polos para una fácil conexión integrada. Posibilidad de controlar hasta 5 Wall Piercings. Si existen más Wall Piercings en la misma instalación, es necesario ampliar la señal con interfaces "Slave". Unidad de alimentación electrónica no incluida.

White

06.1019.00

M

RGB

06.1012.00

M

DMX Master interface with 5 pole distributor for easy connection integrated. It's able to control up to 5 Wall piercing. If more Wall Piercings are in the same installation it's necessary to expand the signal with Slave interfaces. Electronic power supply not included.

Interfaz "Master" DMX con distribuidor de 5 polos para una fácil conexión integrada 06.1005.00. Posibilidad de controlar hasta 5 Wall Piercings. Si existen más Wall Piercings en la misma instalación, es necesario ampliar la señal con interfaces "Slave". Unidad de alimentación electrónica no incluida.

06.1005.00

M

SOFT ARCHITECTURE | 3D

LED DRIVERS

For Wall Piercing

Dimmable Interfaces Interfaces Regulables

Radio Frequency (RF) RGB Master interface with 5 pole distributor for easy connection integrated. Wall transmitter to make color changing integrated. It's able to control up to 5 Wall Piercings. If more Wall Piercings are in the same installation it's necessary to expand the signal with Slave interfaces. Electronic power supply not included.

Interfaz "Master" RGB Radio Frecuencia (RF) con distribuidor de 5 polos para una fácil conexión integrada. Transmisor de pared integrado para crear cambios de color. Posibilidad de controlar hasta 5 productos Wall Piercings. Si existen más Wall Piercings en la misma instalación, es necesario ampliar la señal con interfaces "Slave". Unidad de alimentación electrónica no incluida.

Slave interface to expand the DALI/DMX/RF signal with two 5 pole distributors for easy connection. It's able to expand the Master signal in 10 Wall Piercings. If more Wall Piercings are in the same installation it's necessary to expand the signal with more Slave interfaces. Electronic power supply not included.

Interfaz "Slave" para ampliar la señal DALI/DMX/RF con dos distribuidores de 5 polos para una fácil conexión. Posibilidad de ampliar la señal "Master" en 10 Wall Piercings. Si existen más Wall Piercings en la misma instalación, es necesario ampliar la señal con más interfaces "Slave". Unidad de alimentación electrónica no incluida.

2 meters prolongation cable for LED modules with fast connection. Can be connected with each other to greater length. 20 meters max.

2 metros de prolongación de cable para módulos LED con conexión rápida. Pueden conectarse entre sí para una mayor longitud. 20 metros máximo.

White

RGB

06.1013.00

M

06.1020.00

S

06.1014.00

S

08.8297.00

08.8298.00

Power Supply / Unidad de Alimentación

Installation in False Ceiling Instalación en Falso Techo

PS

Remote Installation Electrical Panel Instalación Remota en Cuadro Eléctrico

PS

Electronic 25W / Electrónica 25W

Power supply / Fuente de alimentación LED. 25W – 24V. 100-240V, 50-60Hz.

60.8703

Electronic 240W / Electrónica 240W

Power supply / Fuente de alimentación LED. 240W – 24V. 100-240V, 50-60Hz.

60.8268

Electronic 60W / Electrónica 60W

Power supply / Fuente de alimentación LED. 60W – 24V. 100-240V, 50-60Hz.

60.9089

Electronic 120W / Electrónica 120W



Power supply / Fuente de alimentación LED. 120W – 24V. 100-240V, 50-60Hz.

60.9407

Installation Guidelines

Tablas de Instalación

White/RGB

		20W	60W	100W	150W	240W
Wall Piercing		2	8	13	20	32
Cable section (installer provides) Sección de cable (el instalador lo suministra)		0,5mm ²	0,5mm ²	0,75mm ²	0,75mm ²	1mm ²
Max distance Distancia máxima		5m	10m	15m	30m	50m
Max distance Distancia máxima		20m				
Max distance Distancia máxima		20m				

Soft Spun Halogen Small Designed By Sebastian Wrong

Light Source: QT-DE-12 1xR7s - max 120W

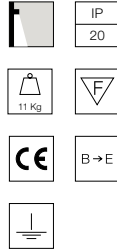
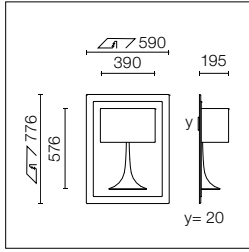

Recessed luminaire for halogen lamp, direct connection to mains.

Luminaria empotrable para lámpara halógena directa a red.

See Flos Decorative Collection catalogue.

Ver catálogo FLOS Decorative Collection.

SA.5005.1

Soft Spun Halogen Large Designed By Sebastian Wrong

Light Source: QT-DE-12 1xR7s - 160W (diffuser) / LED White 1,4W - 80 lm - 2700K/CRI>90 (base)

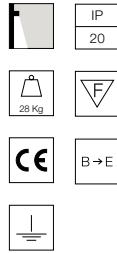
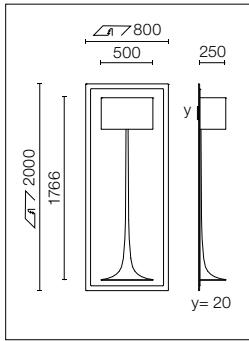

Recessed luminaire for halogen lamp, direct connection to mains. Electronic LED driver 220-240V / 50-60Hz integrated.

Luminaria empotrable para lámpara halógena directa a red. Conductor LED electrónico 220-240V / 50-60 Hz integrado.

See Flos Decorative Collection catalogue.

Ver catálogo FLOS Decorative Collection.

SA.5009.1

Soft Spun Fluorescent Small Designed By Sebastian Wrong

Light Source: TC-L 2x2G11 - 18W

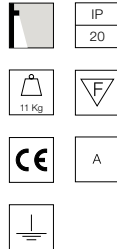
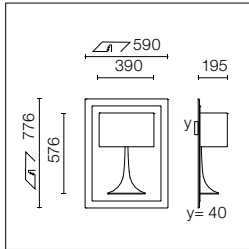

Recessed luminaire for fluorescent lamp Non-dimmable 220/240V ballasts included.

Luminaria empotrable para lámpara fluorescente. Balastos 220/240V no dimables incluidos.

See Flos Decorative Collection catalogue.

Ver catálogo FLOS Decorative Collection.

SA.5004.1

Soft Spun Fluorescent Large Designed By Sebastian Wrong

Light Source: TC-L 2x2G11 - 24W (diffuser) / LED White 1,4W - 80 lm - 2700K/CRI>90 (base)

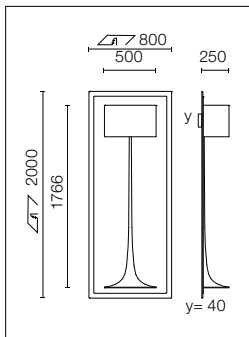

Recessed luminaire for fluorescent lamp Non-dimmable 220/240V ballasts included.

Luminaria empotrable para lámpara fluorescente. Balastos 220/240V no dimables incluidos.

See Flos Decorative Collection catalogue.

Ver catálogo FLOS Decorative Collection.

SA.5008.1

Soft Spun LED Small Designed By Sebastian Wrong

Light Source: LED White 35W - 1800 lm - 3000K/CRI 90

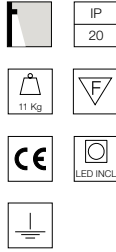
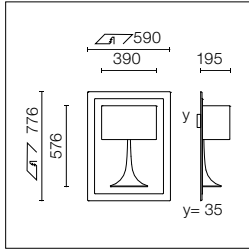

Recessed luminaire for LED lamp. Non-dimmable 220/240V power supply included.

Luminaria empotrable para lámpara LED. Alimentador 220/240V no dimable incluido.

See Flos Decorative Collection catalogue.

Ver catálogo FLOS Decorative Collection.

SA.5006.1D

Soft Spun LED Large Designed By Sebastian Wrong

Light Source: LED White 35W - 1800 lm - 3000K/CRI 90 (diffuser) / LED White 1,4W - 80 lm - 2700K/CRI>90 (base)

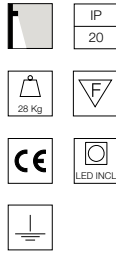
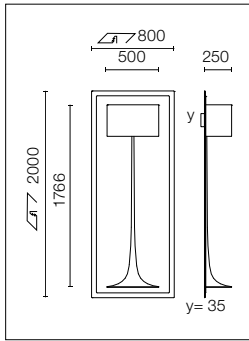

Recessed luminaire for LED lamp. Non-dimmable 220/240V power supply included.

Luminaria empotrable para lámpara LED. Alimentador 220/240V no dimable incluido.

See Flos Decorative Collection catalogue.

Ver catálogo FLOS Decorative Collection.

SA.5007.1D

Abajourd'hui Small Designed By Flos Soft Architecture

Light Source: QT-32 E27 - max 75W

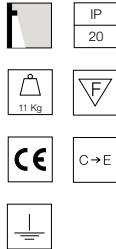
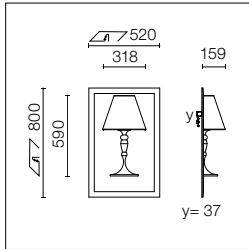

Recessed luminaire with direct connection to mains. Excluded light source. To be ordered separately.

Luminaria empotrable con alimentación directa a red. Fuente de luz no incluida. Se ha de pedir por separado.

See Flos Decorative Collection catalogue.

Ver catálogo FLOS Decorative Collection.

SA.5001.1

Abajourd'hui Large Designed By Flos Soft Architecture

Light Source: QT-32 E27 - max 150W

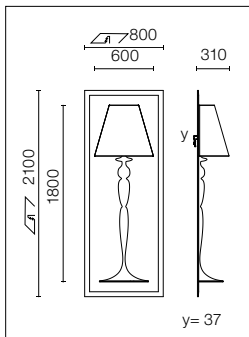

Recessed luminaire with direct connection to mains.

Luminaria empotrable con alimentación directa a red.

See Flos Decorative Collection catalogue.

Ver catálogo FLOS Decorative Collection.

SA.5000.1